

## Installation, use and maintenance manual

**ZEN 50**

**12/24 V dc**



CE

**Model.: ZEN 50**

**Matriculation number: 50Z12/24B**

**Year of construction: 2018**

**Schenker Italia**

Via Delle Repubbliche Marinare, 67

80147 Naples Italy

Tel. +39 081 5593505

Fax. +39 081 5597372

E-mail: info@schenker.it

**[www.schenkerwatermakers.com](http://www.schenkerwatermakers.com)**

## INDEX

|  |    |
|--|----|
| 1. LAYOUT OF MANUAL.....   | 4  |
| 1.1 STRUCTURE OF THE MANUAL .....  | 4  |
| 1.2 DESCRIPTION OF THE PICTOGRAMS.....   | 4  |
| 2. GENERAL WARNINGS AND INFORMATION TO THE RECIPIENT .....                     | 5  |
| 2.1 IMPORTANT INFORMATION .....  | 5  |
| 2.2 SAFETY WARNINGS .....  | 5  |
| 2.3 WARRANTY.....  | 6  |
| 2.4 IDENTIFICATION OF THE UNIT .....   | 7  |
| 2.5 LEGISLATIVE REFERENCE .....  | 7  |
| 2.5.1 DIRECTIVES AND STANDARDS CONCERNING MACHINE SAFETY.....                  | 7  |
| 2.5.2 RESPECT FOR THE ENVIRONMENT – REQUIREMENTS FOR REMOVAL AND DISPOSAL..... | 7  |
| 3. PRODUCT PRESENTATION .....  | 9  |
| 3.1 TRANSPORT AND MATERIAL HANDLING .....                                      | 9  |
| 3.2 STOCK.....   | 10 |
| 3.3 PACKAGING.....   | 10 |
| 3.3.1 PACKAGING CONTENTS.....  | 10 |
| 3.4 ATTACHED DOCUMENTS .....   | 11 |
| 3.5 TECHNICAL DATA .....   | 11 |
| 3.6 FEATURES OF THE PRODUCT .....  | 12 |
| 3.7 ADVANTAGES OF THE ENERGY RECOVERY SYSTEM .....                             | 13 |
| 3.8 COMPOSITION OF THE MACHINE .....   | 14 |
| 3.8.1 PUMP GROUP.....  | 14 |
| 3.8.2 WATERMAKER GROUP.....  | 15 |
| 3.8.3 ACCESSORIES .....  | 17 |
| 4. MOUNTING AND INSTALLATION.....  | 18 |
| 4.1 GENERAL CRITERIA .....   | 18 |
| 4.2 COMPONENTS MOUNTINGS .....   | 19 |
| 4.2.1 PUMP GROUP.....  | 19 |
| 4.2.2 WATERMAKER GROUP .....   | 19 |
| 4.2.3 ACCESSORIES.....   | 22 |
| 4.3 INSTALLATION .....   | 22 |
| 4.3.1 WATER INTAKE AND DISCHARGE.....  | 22 |
| 4.3.2 SEAWATER INTAKE.....   | 22 |
| 4.3.3 FRESH WATER CONNECTION FOR FLUSHING .....                                | 23 |
| 4.3.4 BRINE DISCHARGE .....  | 23 |
| 4.4 HYDRAULIC CONNECTIONS .....  | 24 |
| 4.5 ELECTRIC CONNECTIONS.....  | 27 |
| 4.5.1 REMOTE CONTROL PANEL MOUNTING .....                                      | 27 |
| 4.5.2 ELECTRIC CONNECTIONS: WIRES (ZEN 50 12/24V DC) .....                     | 28 |
| 5. FUNCTIONING AND USE.....  | 30 |
| 5.1 COMMAND DESCRIPTION.....   | 30 |
| 5.2 FIRST START UP PROCEDURE.....  | 30 |
| 5.2.1 PRELIMINARY CHECKS BEFORE PROCEEDING WITH THE START-UP PROCEDURE .....   | 30 |
| 5.2.2 START-UP.....  | 31 |
| 5.3 NORMAL OPERATING PROCEDURE .....   | 32 |
| 5.3.1 NORMAL OPERATING PROCEDURE WITHOUT FINAL FLUSHING .....                  | 32 |

|  |           |
|--|-----------|
| 5.3.2 NORMAL OPERATING PROCEDURE WITH FINAL FLUSHING (RECOMMENDED PROCEDURE) ..... | 32        |
| 5.3.3 WORKING CYCLE WITH TIMER .....   | 33        |
| 5.3.4 WORKING CYCLE WITH ONE PUMP .....  | 33        |
| 5.4 RESET PROCEDURE .....  | 34        |
| <b>6. MAINTENANCE (ROUTINE AND SPECIAL).....</b>                                   | <b>37</b> |
| 6.1 CHECK FILTER CLEANLINESS .....   | 37        |
| 6.2 CHECK THE PLANT WORKING PRESSURE .....   | 38        |
| 6.3 CHECK FOR LEAKS.....   | 38        |
| 6.4 CHECK FOR MEMBRANES REPLACEMENT .....  | 38        |
| 6.5 SHUTDOWN PROCEDURE .....   | 38        |
| 6.5.1 NECESSARY EQUIPMENT .....  | 39        |
| 6.5.2 SHUTDOWN OPERATING PROCEDURE.....  | 40        |
| 6.6 ANTIFREEZE PROCEDURE (WINTERIZING PROCEDURE IN COLD CLIMATE - UNDER 5°C).....  | 42        |
| 6.7 PERIODIC MAINTENANCE.....  | 43        |
| 6.7.1 MEMBRANE REPLACEMENT.....  | 43        |
| 6.8 ADJUSTMENTS .....  | 43        |
| <b>7. TROUBLESHOOTING.....</b>   | <b>44</b> |
| 7.1 TROUBLESHOOTING CHART.....   | 44        |
| <b>8. SUGGESTED SPARE PARTS.....</b>   | <b>45</b> |
| 8.1 SHORT TERM CRUISING.....   | 45        |
| 8.2 LONG TERM CRUISING .....   | 45        |

## 1. LAYOUT OF MANUAL

### 1.1 Structure of the manual

The manual is divided into chapters, which gather all the information necessary to use the system without risk. Within each chapter there is a subdivision in paragraphs to focus on essential points; each paragraph can be found with a subtitle and a description.

At the top of each page the heading section is to remind the reader of the scope of the page.

Within the chapter, for example chapter 1, we will have:

|         |                   |
|---------|-------------------|
| 1       | Chapter title     |
| 1.1     | Paragraph title   |
| 1.1.1   | Subtitle          |
| 1.1.1.1 | Further subtitles |

The numbering of the figures and tables, is reset to each chapter; therefore, we will find the prefix indicating the chapter and the page number, figure or table in progressive that starts from number 1 at the beginning of each chapter.

### 1.2 Description of the pictograms

The following symbols will be used in the manual to highlight important indications and warnings:



**ATTENTION:**

This symbol indicates accident prevention regulations for the operator and / or for any exposed persons.



**CAUTION:**

This symbol indicates that there is the possibility of damaging the system and / or its components.



**NOTE:**

This symbol indicates useful information.

## 2. GENERAL WARNINGS AND INFORMATION TO THE RECIPIENT

### 2.1 Important information

To safeguard the operator's safety and to avoid possible damage to the machine, before carrying out any operation on the machine, it is essential to read carefully all the instructions manual.

This manual must be complete and legible in its entirety, every operator involved in the use of the machine, or responsible for maintenance or adjustment operations, must know its location and must have the possibility to consult it at any time.

All rights of reproduction of this manual are reserved to SCHENKER ITALIA. This manual cannot be transferred to third parties without the written authorization of SCHENKER ITALIA.

The text cannot be used in other printed matter without the written permission of SCHENKER ITALIA.

The descriptions and illustrations provided in this publication are not binding.

SCHENKER ITALIA reserves the right to make any modifications it deems appropriate.

© SCHENKER ITALIA

THIS MANUAL IS PROPERTY OF SCHENKER ITALIA, ANY REPRODUCTION, EVEN PARTIAL, IS PROHIBITED.

This manual was drafted according to the requirements of the 2006/42 / EC Machinery Directive.

### 2.2 Safety warnings

- Wear protective equipment suitable for service operation.
- Clothing must be tight to the body, and resistant to the products used for cleaning.
- Do not remove safety devices or accident prevention protection.
- To check if the plant is correctly installed contact a Schenker service point.
- Verify that the electric and hydraulic connections are in keeping with the indicated specifications.
- Avoid using the plant if the sea water is polluted.
- Children and inexperienced people shall not touch or operate the plant.
- Check periodically that no leaks are present. Avoid installing the plant where a leak may cause damage and/or jeopardize the safety of the vessel.
- Maintenance should only be carried out by suitably qualified persons or Schenker personnel.



## **ATTENTION**

***Any technical changes or operating conditions indicated that affect the correct operation or safety of the machine must only be carried out by the manufacturer's technical staff or by technicians formally authorized by the manufacturer. Otherwise, SCHENKER ITALIA declines any responsibility for changes or damages that may result from it.***

### **2.3 Warranty**

The equipment and the relevant accessories are guaranteed 12 months from delivery. The guarantee does not include consumable items (filters, carbon filters, membranes, etc.). The "ERS" pressure amplification device is guaranteed 36 months, provided that the annual maintenance is performed at a Schenker service point.

The guarantee covers faults, defect of materials and parts. It is limited to the replacement or re-pair of faulty parts. The expense for the disconnecting and reinstalling on the vessel and transport of the equipment from or to our Service Point, or our factory will be at the customers own expense.

The under guarantee delivered parts transport, will be at customer's own risk.

In case of repairs under guarantee performed by our technicians on the customer's vessel, the faulty parts replacement cost will be at Schenker's expense, while manpower and travel expenses will be charged to the customer. The guarantee does not include faults caused by negligence in operating, maintenance and installation of the device (if not carried out by an authorised Schenker Service point).

Dismantling by non-authorized personnel will render void all guarantees. Schenker Italia cannot be held liable for any direct or indirect damage caused by the malfunctioning equipment, limiting its responsibility to the repair and replacement of faulty parts.



## **ATTENTION**

***SCHENKER ITALIA declines any responsibility for improper use of the machine, for damages caused as a result of operations not covered by this manual or unreasonable use.***

## 2.4 Identification of the unit

The Zen can be identified through a serial number printed on the left flange of the unit.



Serial number  
Fig. 2-1

## 2.5 Legislative reference

### 2.5.1 Directives and standards concerning machine safety

- Machinery Directive 2006/42 / EC, in force since December 29, 2009;
- Low Voltage Directive 73/23 / EEC and subsequent amendments and additions: 93/68 / CEE implemented by the Law of 18 October 1997 n. 791.
- Electromagnetic Compatibility Directive 89/336 / EEC and subsequent amendments and additions: 93/31 / CEE implemented with D.L. December 4, 1992 n. 476.
- Standards UNI EN 292/1 and 292/2 (safety of machinery);

### 2.5.2 Respect for the environment – requirements for removal and disposal



#### **ATTENTION**

***Removal and disposal of materials, as result of the decommissioning of the machine, must be performed in accordance with the regulations in force, for the safeguard and protection of the environment.***

With regard to removal and disposal, it should be noted that the materials of which the machine is made of are not of a dangerous nature and consist essentially of:

- Stainless Steel;
- Plastic;
- Carbon fibre;

- Motors, cables and consumable electrical materials;
- Rubber and polyurethane seals.

After dismantling the machine, the various materials must be segregated according to the regulations of the country in which the machine has been removed.

The machine does not contain dangerous components or substances that require special removal procedures.



**ATTENTION**

***Different legislations are in force in the different countries, therefore the prescriptions imposed by the laws and by the agencies designated by the Countries must be observed.***



## 3. PRODUCT PRESENTATION



### ATTENTION

**Be sure to follow general safety instructions.**

- Wear protective equipment suitable for the transport and handling operations.
- Lift the machines with equipment appropriate to the weight and size of the box, taking the utmost care and following carefully the instructions on the present use and maintenance manual (attachment points for loading devices, etc.).
- Make sure that the lifting equipment used is in good condition and correctly maintained.
- Do not stand or pass under the groups to be moved during lifting or transport operation.

### 3.1 Transport and material handling

The watermaker unit is transported in a cardboard box. In the following table dimension and weight are indicated.



MATERIALS HANDLING  
fig. 3-1

|  | Model  | L cm. | W cm. | H cm. | Weight Kg. |
|--|--------|-------|-------|-------|------------|
|  | Zen 50 | 82    | 49    | 50    | 45         |

Packaging dimensions and weight  
tab.3-1

## 3.2 Stock



### ATTENTION

To avoid damage to the system, store the unit in a dry place at a temperature of between 5°C and 35°C. Very cold temperatures could lead to a freezing of the fluid inside the system with the consequence of a permanent damage of the system.

## 3.3 Packaging

### 3.3.1 Packaging contents



PACKAGING  
FIG. 3-2

| ZEN 50                                 |  |
|--|--|
| Watermaker                             | Pump group                             |
| Active carbon filter with electrovalve | 5 microns filter with accumulator      |
| Mesh filter                            | Non-return valve with Tee fitting      |
| Remote panel                           | 10 mt extension cable for remote panel |
| Installation kit                       | Filter key                             |
| 6x8 hose for production                |  |

### 3.4 Attached documents

The packaging contains the technical documentation (use and maintenance manual, electric and hydraulic scheme, warnings and instructions).



#### ATTENTION

- Read carefully the use and maintenance manual before installing the system.
- Use only recommended material for the installation (especially hoses, fittings and seals) in accordance with the manual.
- Do not store the unit under temperature below 5°C and above 35 °C



DOCUMENTS INCLUDED IN THE PACKAGING  
FIG. 3-3

### 3.5 Technical data

#### WATERMAKER

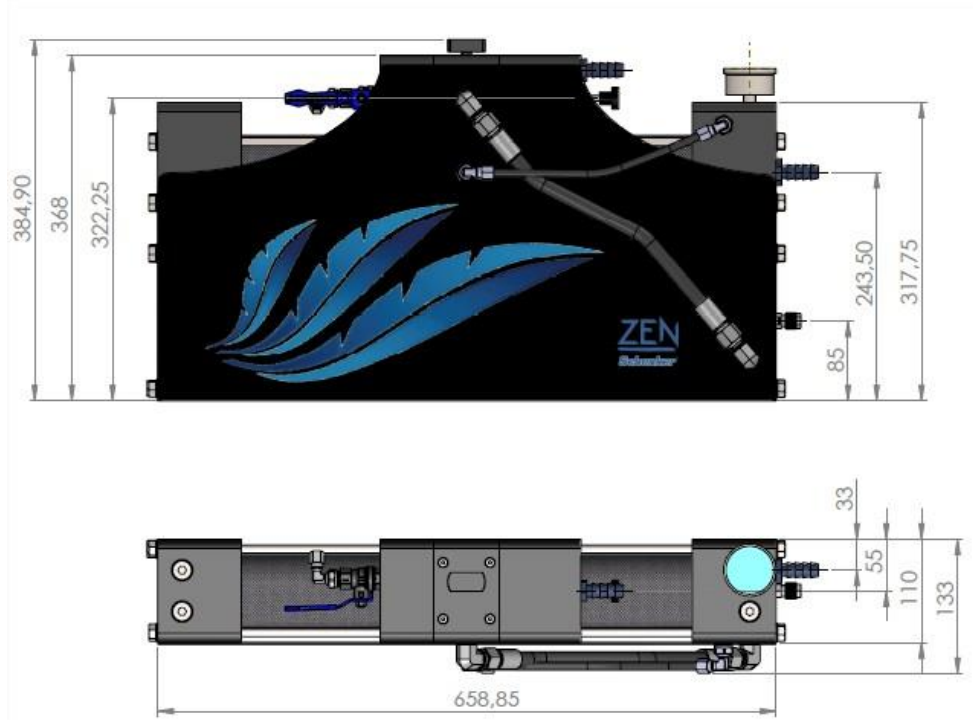

WATERMAKER DIMENSIONS  
FIG. 3-4

*Hydraulic Connection*

Seawater inlet: hose barb for 16mm internal diameter reinforced hose.  
Brine Discharge: hose barb for 16mm internal diameter reinforced hose.  
Fresh water: ¼" fitting, 6x8mm hose.

**PUMP***Dimensions*

Length: 44 cm  
Width: 23 cm  
Height: 29 cm  
Weight: 10 Kg

*Hydraulic Connection*

Water inlet: hose barb for 16mm internal diameter reinforced hose.  
Water outlet: hose barb for 16mm internal diameter reinforced hose.

**Feed pump type:** Shurflo diaphragm pump

**Filters:** n. 1 Cartridge filter 5 microns 2.32" x 9 ¾"  
n. 1 Active carbon filter 2.32" x 9 ¾"

**Power supply:** 12 VDC +/- 15% (50Z12 version)  
24 VDC +/- 15% (50Z24 version)

**Average electric consumption:** 250 Watt/h average

**Peak electric consumption:** 400 Watt

**Nominal fresh water production:** 50 Lit/h +/- 20% @ seawater 25 °C salinity 35.000 ppm

**Fresh water quality:** Under 500 ppm TDS average

**CEE conformity:** In compliance with directives 89/392 CEE sect.1 (general safety machines requirements), 89/336 CEE (electromagnetic compatibility), 73/23 CEE (electric safety requirements)

### 3.6 Features of the product

The water produced by a Schenker plant, produced from clean seawater has a purity of between 350 & 450 parts per million Totally dissolved solids (TDS/PPM), but the potability may not be guaranteed as bacterium may be present in the watermaker, caused by non-observance of shutdown and cleaning procedures. It is essential that correct shut down and storage procedures are followed to ensure continued purity of the product water. UV treatment of the product water may be beneficial.

### 3.7 Advantages of the Energy recovery system

#### Introduction

Thank you for choosing a Schenker Watermaker.

As all the equipment, the knowledge of operating and maintenance procedures allows to use the system in the best way, and to guarantee a perfect functioning throughout the years. We invite you to read carefully this manual and to keep it for a quick reference.

#### Functioning principles

The Schenker watermakers, as an alternative to the high-pressure pumps of traditional systems, utilizes the ENERGY RECOVERY SYSTEM patented device, which amplifies the pressure of common low-pressure pumps, and recoup all the hydraulic energy back from the membranes, allowing a high energy efficiency.

The lack of high-pressure pumps makes the system silent and vibration free, and enormously simplifies its use as no adjustment is necessary for its operating.

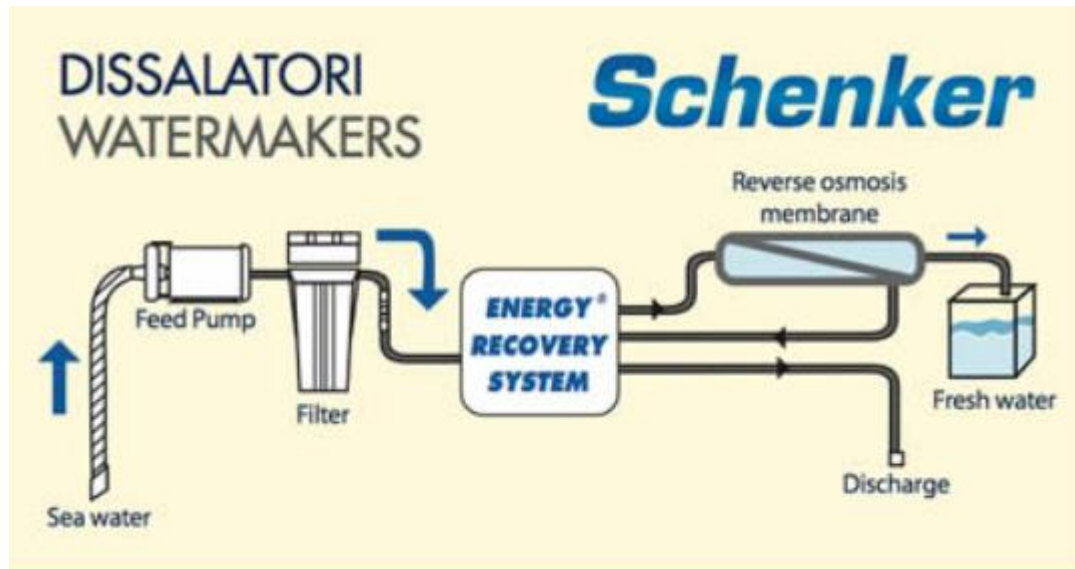

FUNCTIONING SCHEME  
FIG. 3-5

### 3.8 Composition of the machine

The machine is composed of the following parts:

1. PUMP GROUP
2. WATERMAKER GROUP

#### 3.8.1 Pump group

This pump picks up sea water and sends it to the watermaker group, through the pre-filter. The pump group is composed of the following components:

- 5 micron cartridge filter
- Diaphragm pump
- High pressure switch
- Pump box
- Accumulator

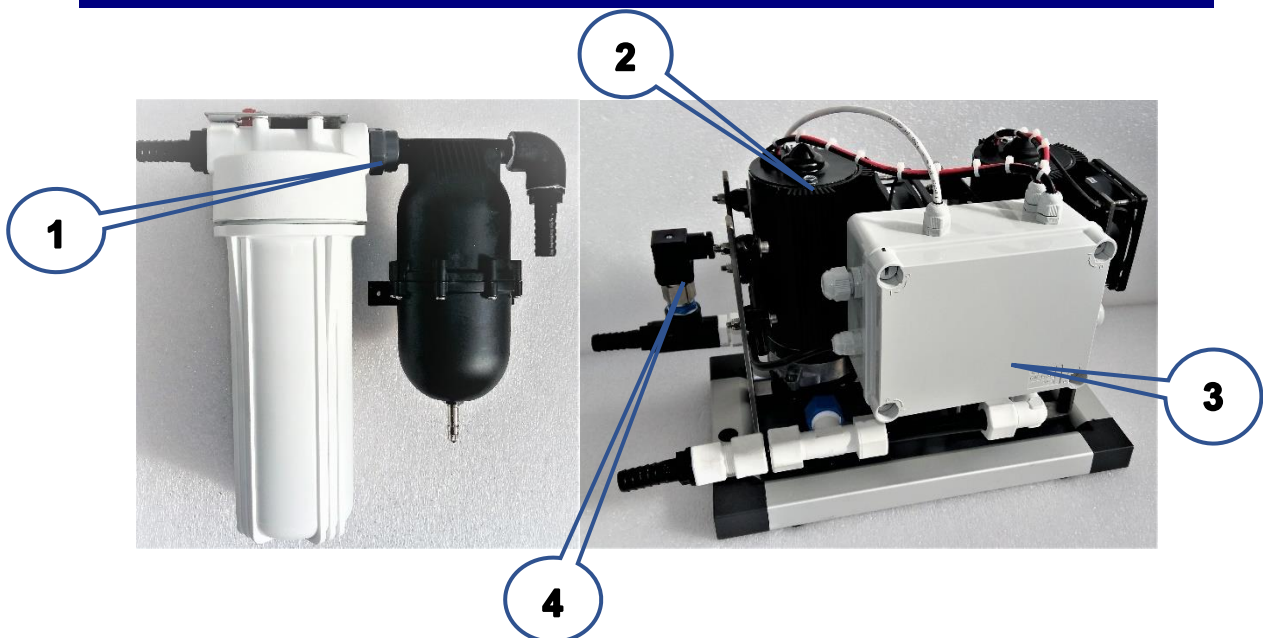

PUMP GROUP AND FILTER 12-24 V DC  
FIG. 3-6

- |  |                               |
|--|-------------------------------|
| ① 5 micron cartridge filter with accumulator | ③ Pump box with controller    |
| ② Diaphragm pumps                            | ④ High pressure safety switch |

## 3.8.2 Watermaker group

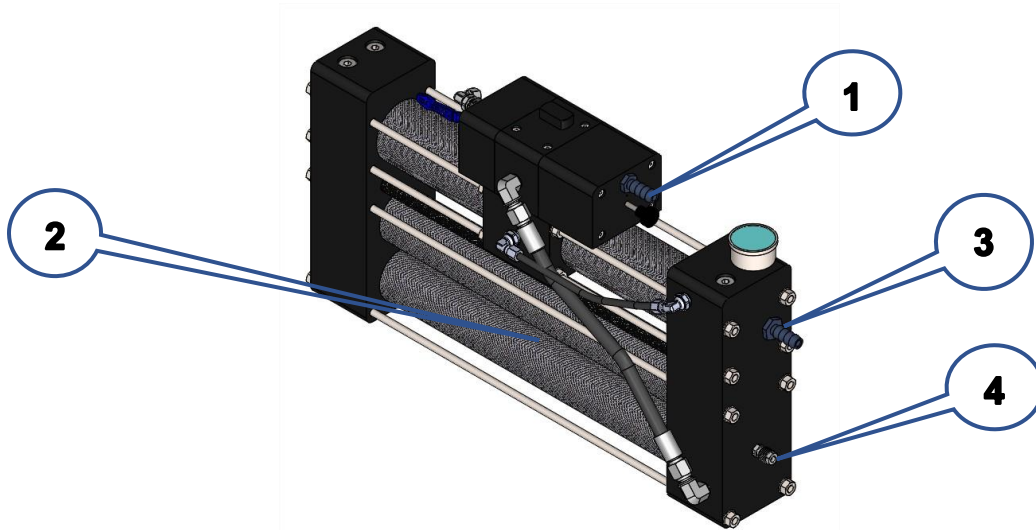

WATERMAKER GROUP (SIDE VIEW W/O COVER)  
FIG. 3-7

- |                               |                          |
|-------------------------------|--------------------------|
| ① Watermaker outlet/discharge | ③ Watermaker inlet       |
| ② Reverse osmosis membranes   | ④ Fresh water production |

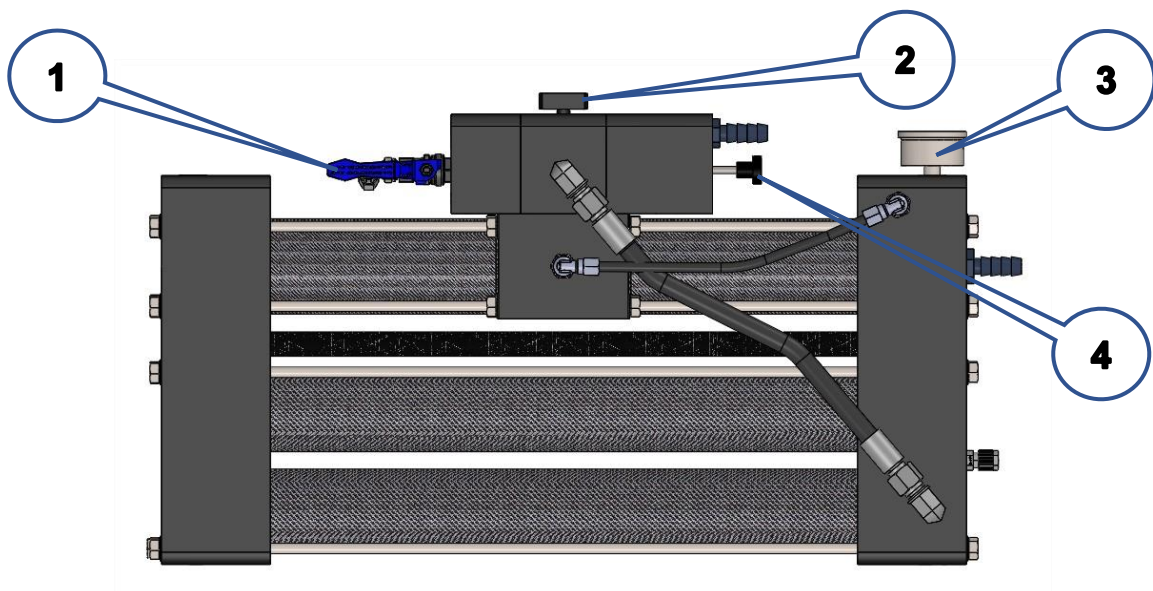

WATERMAKER GROUP (FRONT VIEW W/O COVER)  
FIG. 3-8

- |                          |                   |
|--------------------------|-------------------|
| ① Reset valve            | ③ Manometer       |
| ② Depressurization valve | ④ Positioner knob |

The watermaker group is composed of the following parts:

- Reverse osmosis membranes
- Energy Recovery System
- Manometer
- Accumulator
- Depressurization valve
- Positioner
- Reset valve
- High pressure switch

**Reverse osmosis membranes.** They are installed inside the glass fibre high-pressure housing. Membranes are n.2 x SW2521 type. Their purpose is to separate the intake high-pressure seawater in two flows: one for the salt-water drain and one for the fresh water production.

**Energy Recovery System.** The heart of the system. It has the function of amplifying the pressure supplied by the pumps and to recoup the hydraulic energy back from the membranes. The ERS device makes periodic cycling by a hydraulically controlled automatic valve. The cycles are noticeable through a "beat" issued by the watermaker unit. The unit is based on cylinders and a central body containing the hydraulic valve necessary for the system to function.

**Manometer.** Located on the right side of the watermaker, it measures the working pressure of the watermaker.

**Accumulator.** This is a black air reservoir. Its function is to reduce and stabilize the pressure peaks during the watermaker functioning. The device has to be pre-charged with air through the Schrader valve. The pressure is about 4 Bar. The accumulator is preloaded in factory to the correct pressure.

**Depressurization valve.** It is used for the air bleeding of the unit. It is located on the top of the watermaker. Its function is to depressurize the system and to allow the bleeding of air. The valve must be closed during normal working conditions (completely screwed in) and it is opened during the air bleeding operations (slightly unscrewed).

**Positioner.** It is a stainless steel threaded arm, with a black knob, located on the right hand side of the watermaker. Its function is to reset the unit in case of hydraulic block.

**Reset valve.** It is installed on top of the ERS it is recognizable by the little blue lever. The valve must be closed during normal functioning (lever perpendicular to the valve). This valve has the function of allowing the resetting of the ERS in case of a system block. It must be opened before screwing in the valve positioner.

**High pressure switch.** It is hydraulically connected to the pump group. It stops the system if the pump pressure exceeds 9,5 bar. In this case a high-pressure alarm is activated on the control panel.



### 3.8.3 Accessories

The main accessories of the watermaker are the following:

- Active carbon filter
- Electrovalve
- Non-return valve
- Mesh filter (strainer)

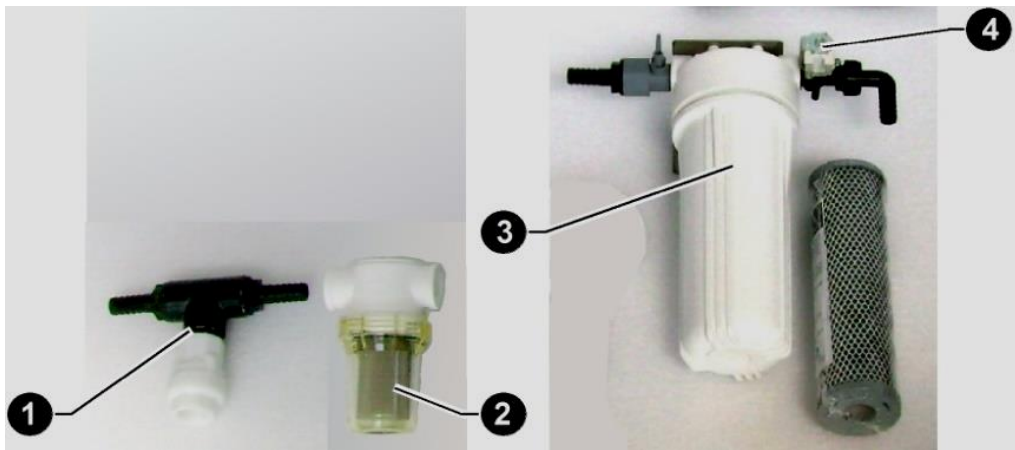

ACCESSORIES  
FIG. 3-9

- ① Non-return valve
- ② Mesh filter

- ③ Active carbon filter
- ④ Electrovalve

**Active carbon filter.** This filter is connected between the fresh water pressurized system of the boat and the electro valve on the filter holder. On the filter inlet is positioned a manual valve that allows replacement of the cartridge without depressurizing the fresh water system of the vessel.

**Electrovalve.** It has the function of switching from seawater intake to fresh water tank when washing the watermaker.

**Non-return valve.** It stops water flowing out of the inlet hose. It must be installed vertically. It stops leaking of fresh water from the seacock whilst the washing procedure commences.

**Mesh filter.** The machine is equipped with a mesh filter to protect the pump from macro sediments. This is placed between the seacock and the pump.

## 4. MOUNTING AND INSTALLATION

### 4.1 General criteria

Before commencing the installation, it is important to carefully plan all the activities, by evaluating all of the siting locations of the equipment. The main points to focus on are the following:

- Selecting of seawater inlet/outlet
- Positioning of the main units (pump group, watermaker group, active carbon filter).
- Positioning of the thermal-magnetic circuit breaker.
- Routing of the hoses and electric cables.



#### **CAUTION**

*For a correct installation of the watermaker please follow the instructions below:*

- *The through-hull fitting should be located in a central and low position on the hull, in the way that air can't be sucked in to the pump and subsequently the watermaker itself.*
- *The non-return valve has to be installed under seawater level and as close as possible to the through-hull fitting, in vertical position.*
- *The pump must be installed as low as possible in respect of the waterline and as close as possible to the seawater intake (through-hull fitting). No more that 2m away unless a positive feed is achieved by locating the pump below the waterline.*
- *The watermaker unit must be positioned and arranged on an adequate support which is able to sustain the weight (about 30 Kg). The max allowed room temperature where the watermaker is installed must not exceed 40°C*



#### **CAUTION**

*The pump group must be installed in a ventilated place, in order to facilitate the cooling of the electric motor.*



#### **ATTENTION**

*The external surface of motor of the pump can reach high temperature; therefore, it is recommended to avoid possible contacts with inflammable liquids and materials.*



#### **NOTE**

*Once an installation plan has been made it is recommended to make a schematic drawing of the hydraulic and electric connections and attach them to the manual for future reference.*

## 4.2 Components mounting

### 4.2.1 Pump group

The diaphragm pump group must be installed if possible below the waterline, and as close to the water inlet as possible (2m max).

The pump group should be installed in an adequately ventilated area, with the purpose of aiding the cooling of the motor. **The max permitted room temperature must not exceed 40°C.**

Avoid the contact or the proximity with inflammable material or liquid, since the motor surfaces can reach elevated temperatures. Avoid locating the pump wherever a possible loss of water can involve damages or jeopardize its safety. The pump must be installed on a base sufficiently horizontal, suitable to sustain the weight of the group. The pump is normally fixed on the support structure by passing bolts.

### 4.2.2 Watermaker group

Install the watermaker above the pump, or at the same level. The watermaker can be installed both in horizontal and vertical position and can be fixed with L brackets and rubber feet provided. The brackets are color-coded according to the installation.

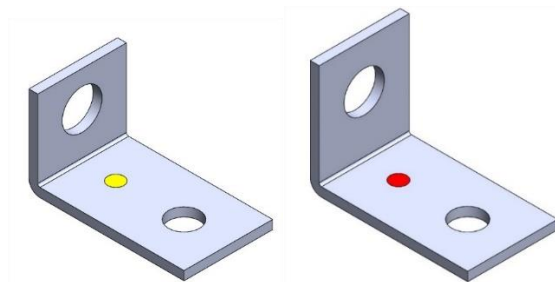

L BRACKETS  
FIG. 4-1

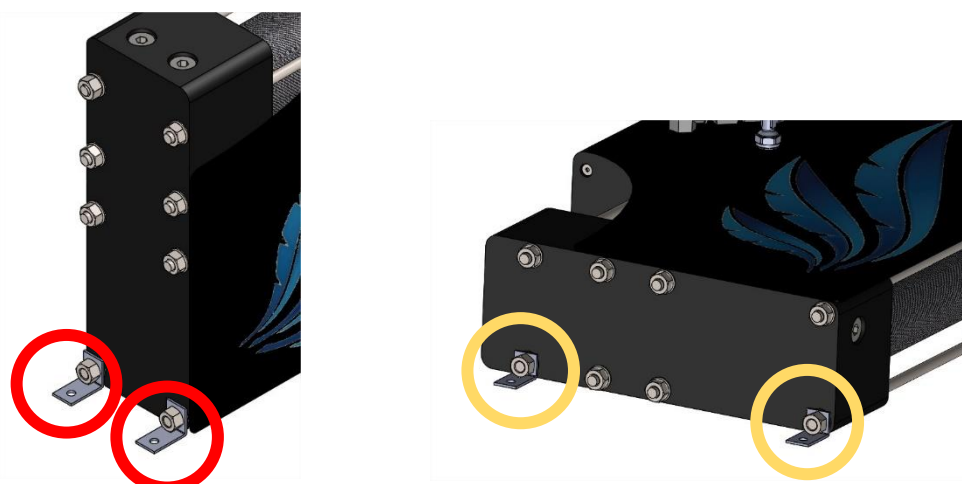

VERTICAL AND HORIZONTAL FIXING  
FIG. 4-2

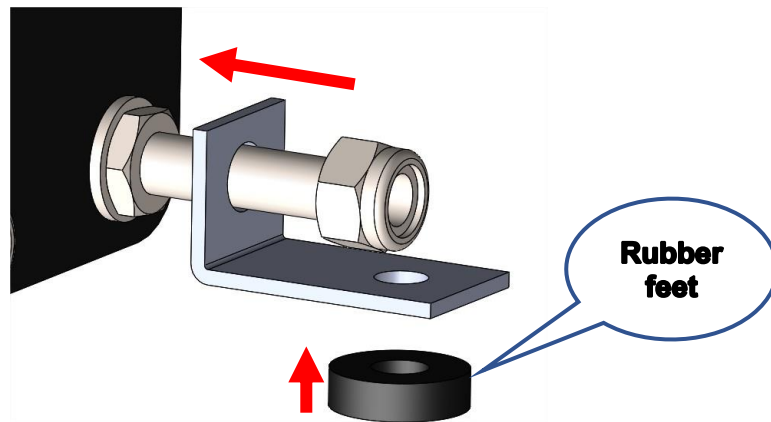

MOUNTING PROCEDURE  
FIG. 4-3

ok



ok



NO



ok



POSSIBLE CONFIGURATIONS  
FIG. 4-4

For a complete installation, antivibration rubber stickers are provided.

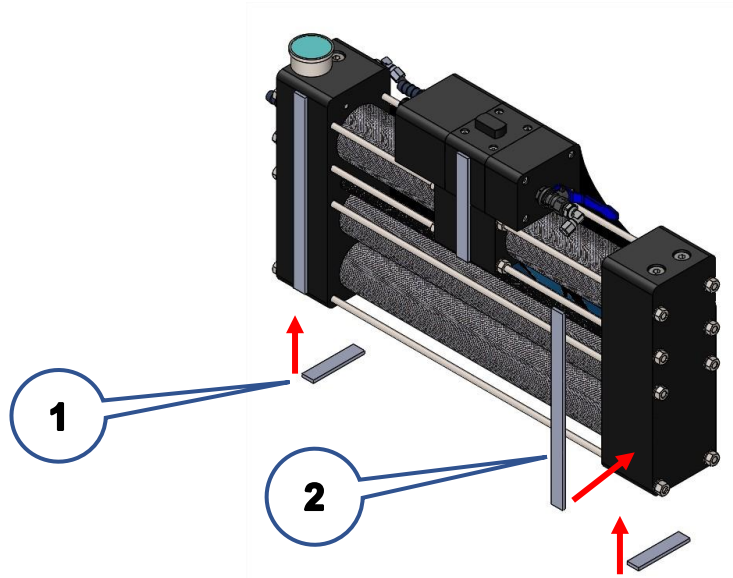

RUBBER STICKER POSITIONS  
FIG. 4-5

❶ Vertical installation

❷ Horizontal installation

If the unit is installed horizontally it is recommended connect the manometer horizontally as well in order to be visible. This can be done making use of the fittings provided.

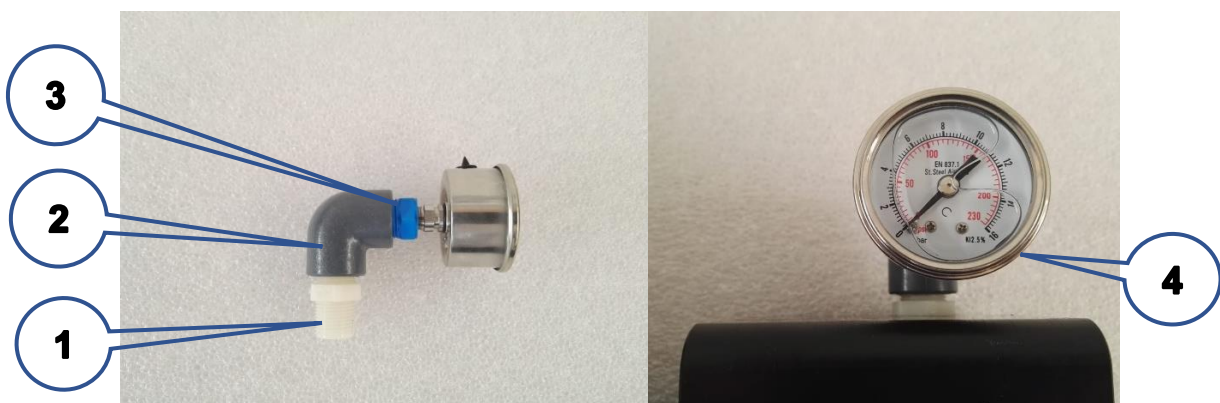

HORIZONTAL FIXING  
FIG. 4-6

❶ 3/8" Nipple  
❷ 3/8" 90°-Degree Elbow

❸ 3/8" male to 1/8" female reducer  
❹ Manometer

### 4.2.3 Accessories

The non-return valve has to be installed vertically as close as possible to the seawater intake, following the direction of the arrow.

The active carbon filter (and the attached electrovalve) has to be placed next to the pump group, if possible, vertically and easily accessible.



## 4.3 Installation

### 4.3.1 Water intake and discharge

For a correct installation of the watermaker it is necessary to arrange the following water intake and discharge out of the board:

- Seawater intake.
- Fresh water intake for washing.
- Brine discharge.

### 4.3.2 Seawater intake

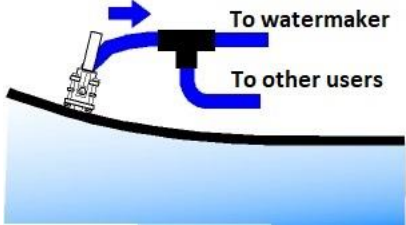
|   |  |  |
|---|--|--|
| <p><b>Seacock with through-hull fitting</b></p>             | <p>The ideal seawater intake should be 3/4" minimum and located in a central position, well under the waterline even when the vessel is well heeled over. A scoop skin fitting is recommended. It must be oriented to the bow of the boat.</p> <p>In case of powerboats with a cruising speed above 15 knot it is advised to make a small hole (8 mm. diameter) on the back of the shape, in order to reduce dynamic prevalence during navigation.</p>   | <p>Size 3/4"</p>   |
| <p><b>Pre-existing seacock adapting (alternatively)</b></p> | <p>As alternative, it is possible Tee into a pre-existent water inlet as long as the following conditions are met:</p> <ul style="list-style-type: none"> <li>3/4" minimum size.</li> <li>The fitting must be located both low and central in the hull and not forward of the keel.</li> <li>No air can be introduced into the system from other use ie: salt water taps in galley.</li> <li>Must always be under the water surface even when the vessel is well heeled over.</li> <li>Must be far from WC discharge.</li> </ul> <p> <b>CAUTION</b><br/>Do not use the pre-existing water inlet of the cooling system dedicated to the motor.</p> | <p>Size 3/4"</p>  |



### INSTALLATION NOTES

- The hose connections, especially if under the seawater level, must be secured with double hose clamps.
- An easily inspected mesh type filter will be required close to the water intake. The filter has to be of 50 Mesh. It is possible to use filters from existing outlets.
- The seawater intake must be at least 3/4" size.



**INSTALLATION NOTES**

*The strainer has to be connected close to the through-hull, and must be easily accessible for inspection.*

**4.3.3 Fresh water connection for flushing**

|   |   |   |
|---|---|---|
| <p><b>Fresh water connection for flushing</b></p> | <p>Tee in downstream the fresh water pressure pump of the boat.<br/>The following conditions must be respected:</p> <ul style="list-style-type: none"> <li>• The flow of the fresh water pump must be <b>min 10 lit/min at 1 bar.</b></li> <li>• Flushing must always be performed with the fresh water pump ON.</li> </ul> | <p><b><i>Fresh water pump of the boat:<br/>Min. flow rate 10 lit/min. at 1 bar.</i></b></p> |
|---|---|---|

**4.3.4 Brine discharge**

|                                    |  |                                   |
|------------------------------------|--|-----------------------------------|
| <p><b>Discharge connection</b></p> | <p>The discharge connection (back to the sea) has to be possibly above the sea level. Minimum size ½" BSP</p>  | <p><b>Minimum size ½" BSP</b></p> |
|                                    | <p>It is possible TEE on existing discharge hoses (for instance tap discharges) provided that there are no returns of dirt water back to the watermaker.</p> |                                   |

## 4.4 Hydraulic connections

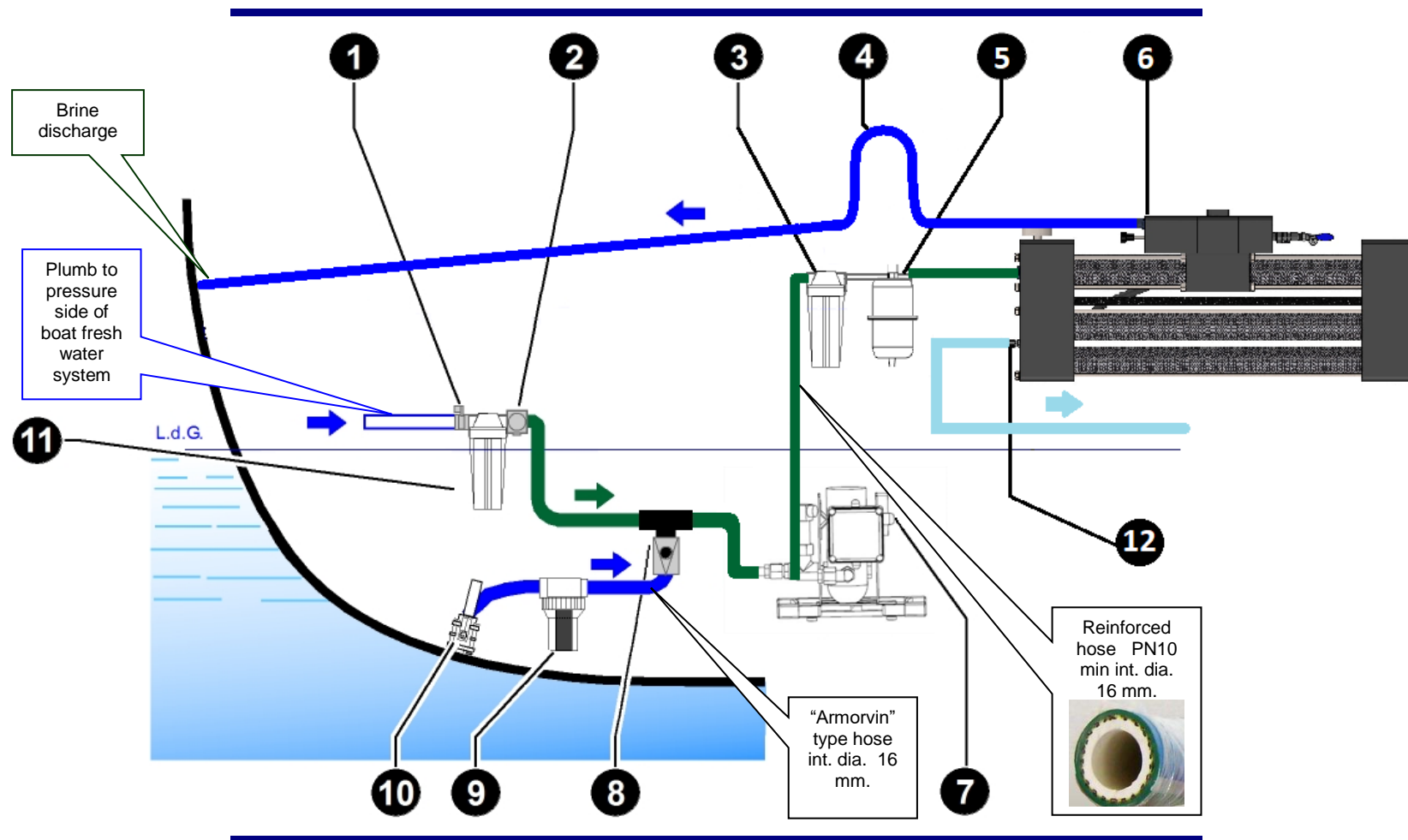

HYDRAULIC CONNECTION AND PIPES  
FIG. 4-7



- |                                 |                        |
|---------------------------------|------------------------|
| ① Pressurized fresh water valve | ⑦ Pump                 |
| ② Electrovalve                  | ⑧ Non return valve     |
| ③ 5 micron filter               | ⑨ Mesh filter          |
| ④ Swan neck upward - Discharge  | ⑩ Water inlet          |
| ⑤ Accumulator                   | ⑪ Active carbon filter |
| ⑥ Watermaker                    | ⑫ Fresh water outlet   |

All the hydraulic connections (with exception of the fresh water production) have to be made with 16 mm. int. diam. hose. The hydraulic section under consistent pressure is the pump outlet – 5 m. filter – watermaker inlet. For this section is necessary to use a good quality **PN 10 min.** reinforced hose. An inadequate hose could burst, seriously jeopardizing the safety of the vessel.

The hydraulic connections are:

|   |   |   |
|---|---|---|
| <b>Low pressure connections – max 3 bar</b>     | <ul style="list-style-type: none"> <li>• Connection between seawater intake –mesh filter – non-return valve inlet – pump group</li> </ul>   | <b>Armorvin reinforced pipe PN 6 with 16mm internal diameter</b>                      |
|   | <ul style="list-style-type: none"> <li>• Connection between the discharge of the watermaker – through hull discharge fittings of the vessel</li> </ul>  | <b>Armorvin reinforced pipe PN6 with 16mm internal diameter</b>                       |
| <b>Medium pressure connections – max 10 bar</b> | <ul style="list-style-type: none"> <li>• Connections fresh water pressurized system– carbon filter-backflow valve outlet–pump inlet</li> <li>• Connections pump outlet-5 microns filter– watermaker inlet.</li> </ul> | <b>Rubber reinforced pipe PN 10 minimum, 16 mm internal diameter.</b>                 |
|   |   |   |
| <b>Low pressure connections – max 3 bar</b>     | <ul style="list-style-type: none"> <li>• Watermaker - fresh water tank</li> </ul>   | <b>¼” fittings, Small plastic blue pipe 6x8mm provided within the scope of supply</b> |
|   |   |   |



### **PUMP CONNECTIONS:**

*Connect the in/out hose to the pump as follows:*

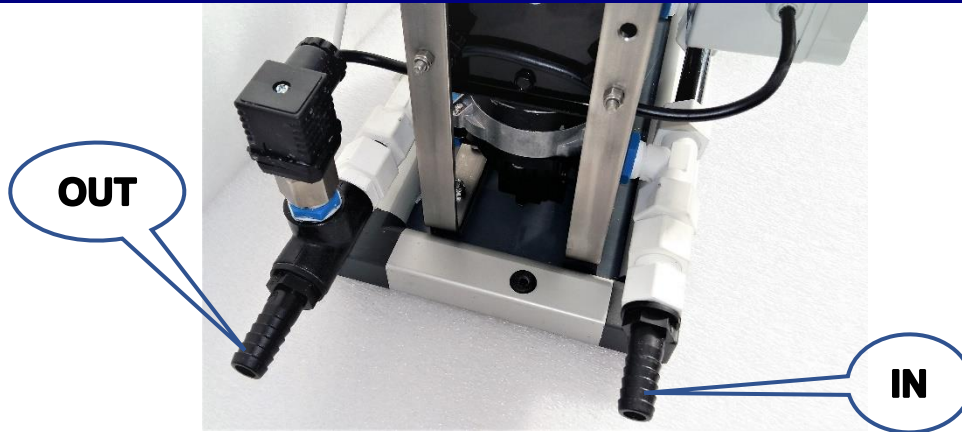

PUMP IN AND OUT  
FIG. 4-8



### **CAUTION**

*The pump has to be placed as close as possible to the seawater intake and as low as possible respect to the seawater level; furthermore, it is recommended to avoid long and convoluted path of the connection hoses.*



### **ATTENTION**

*The use of improper hoses can cause them to burst which endangers the security of the vessel.*

### **WATERMAKER CONNECTIONS:**

#### **WATERMAKER INLET (Sea water inlet from the pump):**

Make use of the holder located on the right side of the watermaker (marked **IN**).

#### **WATERMAKER OUTLET (Discharge outboard):**

Make use, for this connection, of the holder located on right of the unit (marked **OUT**). Create a Swan neck upward, when the drain outlet on the vessel is positioned below the watermaker unit, in order to guarantee a water head.

### **PRODUCTION FRESH WATER CONNECTION**

The connection has to be made using the small hose supplied with the equipment. The connection has to be made between the polyethylene pipe that comes out the watermaker unit (on the right), and the upper side of the tank, on a 1/4" outlet if available.

It is possible, in case of metal tanks, to make a 1/4" threaded hole to connect the supplied male connector. Another option is to Tee into the tank air vent hose. There are no particular limits on the connection length.

## 4.5 Electric connections



### ATTENTION

*These steps have to be performed by a qualified technician/operator, by referring to the electrical drawings provided within this document.*

### 4.5.1 Remote control panel mounting

The remote control panel has the following dimensions:

*width 100 mm. height 66 mm.*

It can be fixed on any internal boat panel, provided that the area behind is free of humidity and condensation and there is enough depth to house the rear part of the panel (approx. 50 mm.).

The cut to be performed on the boat covering panel, to encase the remote control panel, has the following dimensions:

*width 80 mm. height 50 mm.*

The remote control panel can be connected through the pre-wired multiple cable of a 10mt standard length provided. It is possible to require to the factory a longer cable if necessary.



REMOTE CONTROL PANEL  
FIG. 4-9

---

## 4.5.2 Electric connections: wires (ZEN 50 12/24V DC)

The 12/24 V power supply, from the service batteries, must be connected to the +/- clamps on the card of the computer box. A 32 Ampere automatic circuit breaker for 12V systems must be installed on the power supply, while a 16 Ampere for 24V systems.

The connection must be suitable to take the typical electric load (250Watt continuous, 400Watt peak).

The power supply cable section is related to the length of the cable. See the diagram of the recommended sections below.

| Voltage | Automatic switch | Cable lenght |     |           |     |          |     |
|---------|------------------|--------------|-----|-----------|-----|----------|-----|
|         |                  | up to 3 mts  |     | 3 - 7 mt. |     | 7-10 mt. |     |
| Volt    | Ampere           | mm2          | AVG | mm2       | AVG | mm2      | AVG |
| 12      | 32               | 10           | 7   | 16        | 5   | 25       | 3   |
| 24      | 16               | 4            | 11  | 4         | 11  | 6        | 9   |

### The connection diagram in the computer box is the following:

| <i>Clamp</i> | <i>connect to</i>               | <i>cable section</i> |
|--------------|---------------------------------|----------------------|
| -            | Negative battery                | see table            |
| +            | Positive battery                | see table            |
| EV           | Electrovalve (on the AC filter) | 2.5 mm2              |
| EV           | Electrovalve (on the AC filter) | 2.5 mm2              |
| A            | Remote panel                    | 0.22 mm2             |
| B            | Remote panel                    | 0.22 mm2             |
| 12           | Remote panel                    | 0.50 mm2             |
| -            | Remote panel                    | 0.50 mm2             |

The microswitches allow the direct command of the pumps and of the electrovalve. They can be used as an emergency solution for starting the watermaker. They have to be switched off in normal condition. The rated current of the fuse is 400mA.

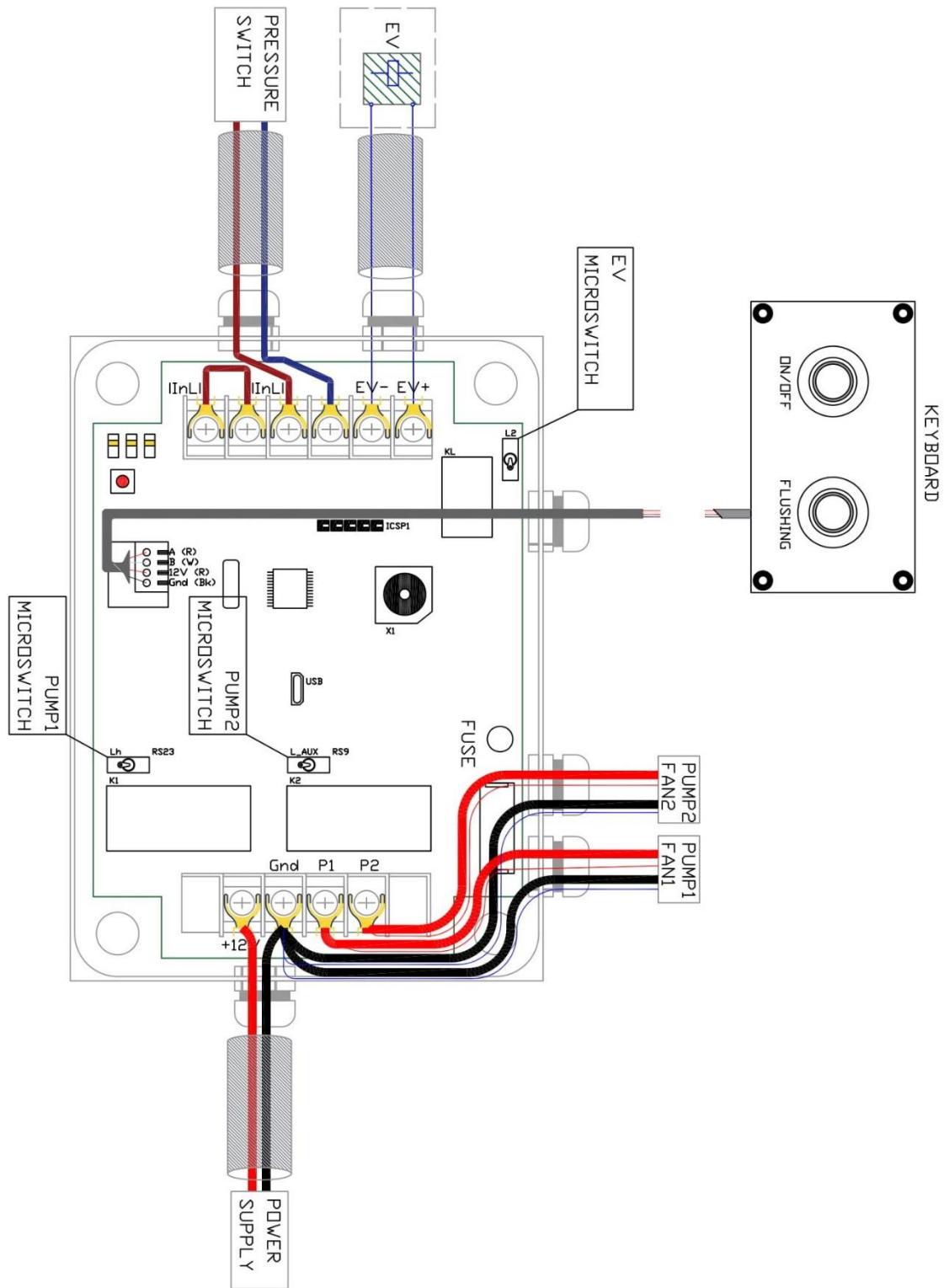

ELECTRIC MAIN BOX SCHEME ZEN 50 12/24V DC  
FIG. 4-10

## 5. FUNCTIONING AND USE

### 5.1 Command description



REMOTE CONTROL PANEL  
Fig. 5.1

---

#### KEYBOARD FEATURES

The panel keyboard has a total of 2 switch buttons. The functions of the buttons are:

**ON/OFF** Used to start and stop the pumps of the system.

**FLUSHING** Used to activate the electrovalve and let the system rinse with fresh water.

### 5.2 First start-up procedure

The first start up procedure is necessary to start a new system or after a filter replacement or a chemical washing.



The start-up procedure is mainly aimed to purge the air separately from the unit and the 2 pumps.

#### 5.2.1 Preliminary checks before proceeding with the start-up procedure

Perform the following checks before proceeding with the start-up procedure:

1. Verify all components and hoses are connected correctly.
2. Verify the 5 micron and active carbon cartridges are installed.
3. Check the seawater inlet valve and salt water drain valve (if existing) are open.
4. Check the reset valve is closed (lever orthogonal to the body valve) and the positioner completely unscrewed.
5. Check the fresh water pressurizing pump of the boat is on.
6. Check the grey valve on the active carbon filter is open.

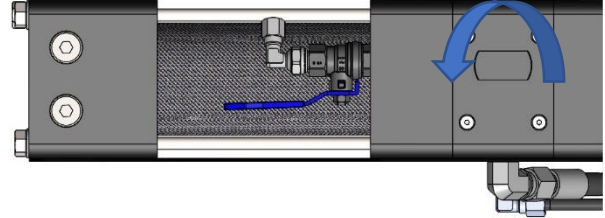
## 5.2.2 Start-up

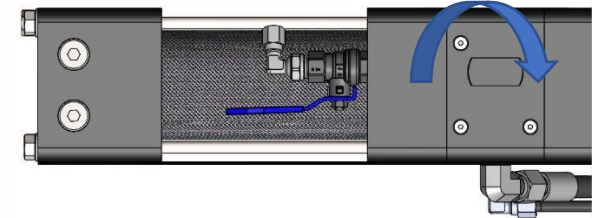
|   |  |
|---|--|
| <p>1. Open the depressurization valve (unscrew the valve).</p>  |    |
| <p>2. Push Flushing for 5 seconds.<br/>The panel emits 2 beeps, the push buttons blinks quickly, and the sequence for purging starts. After about 4 minutes the sequence will finish. The sequence can be stopped at any time pushing ON/OFF.</p> |   |
| <p>3. Start the unit again pushing ON/OFF.</p>  |  |
| <p>4. Close the depressurization valve. The system starts going under pressure and the fresh water production begins. Check the working pressure of the unit is correct (7 – 8 bar).</p>  |  |

5. After a while push FLUSHING in order to flush the unit before stopping it. Then the unit will stop after about 1 minute.



After completed the procedure the system is ready to start normally.

### 5.3 Normal operating procedure

Preliminary checks:

1. Reset valve closed (lever orthogonal to the body valve) and the positioner completely unscrewed.
2. Depressurization valve closed and grey valve on the active carbon filter open.

#### 5.3.1 Normal operating procedure without final flushing

1. Push ON/OFF to start the watermaker.
2. Push ON/OFF to stop the watermaker.



#### 5.3.2 Normal operating procedure with final flushing (recommended procedure)

1. Push ON/OFF to start the watermaker.
2. Push FLUSHING to flush and stop the watermaker. The watermaker will activate a flushing cycle then it will stop itself after 1 minute





### 5.3.3 Working cycle with timer

1. Keep ON/OFF pressed for a while, then you will hear 1-2-3-beeps. Once released ON/OFF the watermaker will work for 1-2-3 hours then will flush and will stop.
2. The unit can be stopped at any time by pushing the ON/OFF button (without final flushing) or the FLUSHING button (with final flushing).



#### CAUTION

The unit is based on 2 parallel pumps (pump 1 and pump 2). The unit works normally with both pumps, producing roughly 50 lit/h and drawing about 240 watt. The unit can also work with a single pump (either pump 1 or pump 2) producing 25 lit/h and drawing about 110 Watt. The sequence to activate a single pump is indicated below.

### 5.3.4 Working cycle with single pump

1. Keep ON/OFF and FLUSHING pressed for a while, then release FLUSHING. Next time watermaker will started, just Pump 1 will work.
2. Keep ON/OFF and FLUSHING pressed for a while, then release ON/OFF. Next time watermaker will be started, just Pump 2 will work.



#### CAUTION

After the cycle with a single pump the unit automatically will return to the normal 2 pumps mode.

## 5.4 Reset procedure

If the watermaker sucks air (or if other problems occur), the automatic hydraulic valve may stop in a central position.

In this case, when the unit is started, it gets suddenly high pressure (close to 10 bar) without cycling. After few seconds the computer recognizes the problem and turn off the pump.

In this case the system has to be manually reset.

This event, besides being very unusual, does not damage the system, but it is necessary to reset the valve with the following simple procedure:

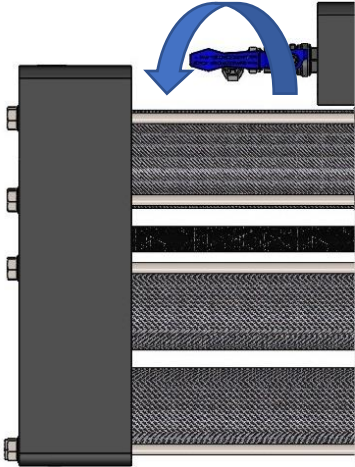
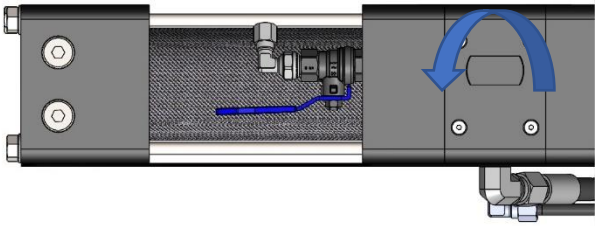
|  |  |
|--|--|
| <p>1. Open the reset valve (lever in horizontal position).</p> |   |
| <p>2. Open slightly the depressurization valve.</p>            |  |

3. Screw the positioner knob clockwise until it can be moved no further. Normally 10 complete turns at least are needed.

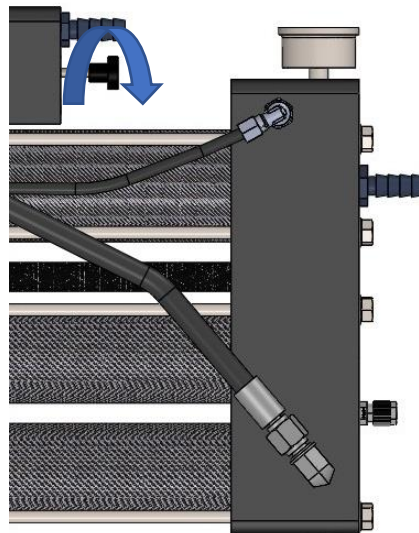

4. Unscrew the positioner knob counterclockwise back to its original position, until it can be turned no more.

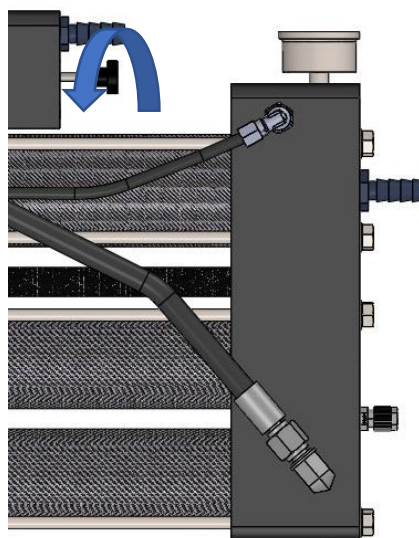

5. Close the reset valve (lever in vertical position).

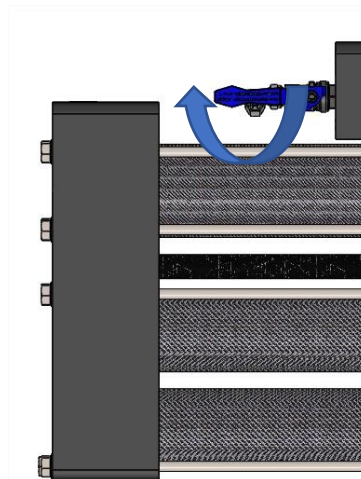

6. Restart the system.



7. After some seconds close the depressurization valve.

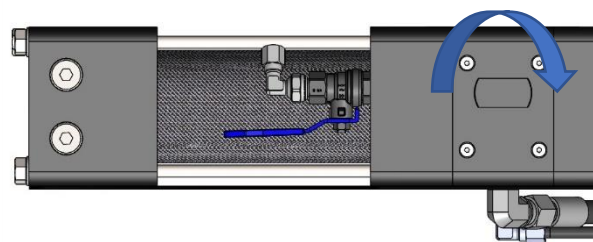



## 6. MAINTENANCE (ROUTINE AND SPECIAL)

### 6.1 Check filter cleanliness

It is very important to inspect filters condition periodically.  
The following filters are present in the system:

1. Strainer
2. Pump filter (5 micron cartridge filter).
3. Active carbon filter.

| OPERATION                                   | FREQUENCY   | PROCEDURE  |
|---|---|--|
| Check and clean the strainer                | Every 5 days  | <p>Visual inspection and washing</p>   |
| Replacing of the 5 micron cartridge filters | It depends on the real working condition and the turbidity of the sea water. In average conditions the replacement of the cartridge is recommended every 100-120 working hours. Once replaced the filters it is necessary to purge the air from the system, opening for 2-3 minutes the depressurization valve. | <p>Unscrew the filter housing counter clockwise by using the specific key provided</p>  |
| Replace the active carbon fibre filter      | Once per year   | <p>Unscrew the filter housing counter clockwise by using the specific key provided</p>  |

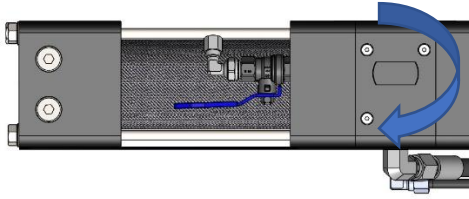
|   |                         |  |
|---|-------------------------|--|
| <p>Purge air from the system periodically by opening for 2-3 minutes the depressurization valve slightly.</p> | <p>Every 15-20 days</p> |  |
|---|-------------------------|--|

## 6.2 Check the plant working pressure

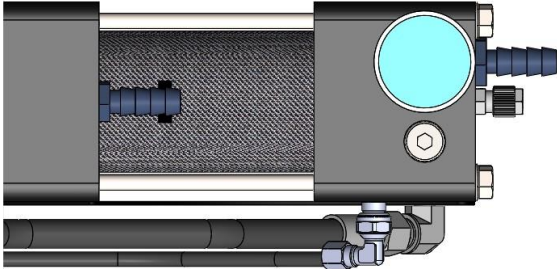
|   |   |
|---|---|
| <p>The working pressure of the pump is indicated on the manometer of the main unit.<br/>         The working pressure depends on many factors such as water temperature, seawater salinity, batteries voltage, membranes conditions, typology of installation.<br/>         The pressure, in normal working conditions, is in the range 7-8 bar. There is periodic small pressure peak (during commutation) of 0,1-0,2 bar.</p> |  |
|---|---|

If the average pressure exceeds the above range it is necessary to check the membranes cleanliness. If the pressure is above the mentioned range probably the membranes are dirty or clogged, and it is necessary to perform a cleaning with the chemical SC1. If the cleaning with SC1 is not enough to reduce the pressure, it could be necessary an alkaline washing with the cleaning SC2.

## 6.3 Check for leaks

It is necessary to perform this verification at every plant start-up and frequently, as possible leaks due to accidental causes (hose bursting, hose clamp loosening, equipment failure, etc.) may occur with the consequence of the possible damage.

## 6.4 Check for membranes replacement

The reverse osmosis membranes last on average 6-7 years. When the membranes are old usually the quality of water decreases and/or the working pressure increases. If chemical washings don't produce significant improvements, it is recommended to replace the membranes.

## 6.5 Shutdown procedure

It is necessary to perform the shutdown procedure before standstills longer than 2-3 months, for instance before the winter laying up.

The purpose of the shutdown is to flush the system from possible organic and inorganic sediments, and inhibit the growth of bacteria that could reduce the reverse osmosis membranes efficiency.

## 6.5.1 Necessary Equipment

The following equipment is necessary to perform the shutdown operation:

1. 1 tank of fill with at least 15 litres of fresh
2. 2 hoses to be connected to:
  - inlet of the pump
  - discharge of the watermaker
3. A bottle of powder **SCHENKER CLEANING 1 (SC1)**. The solution must be prepared following the instruction indicated on the bottle label, and **using unchlorinated water** ( for instance water produced by the system can be an option).
4. Tools for dismounting the system's pipes (screwdrivers, pliers, etc.)

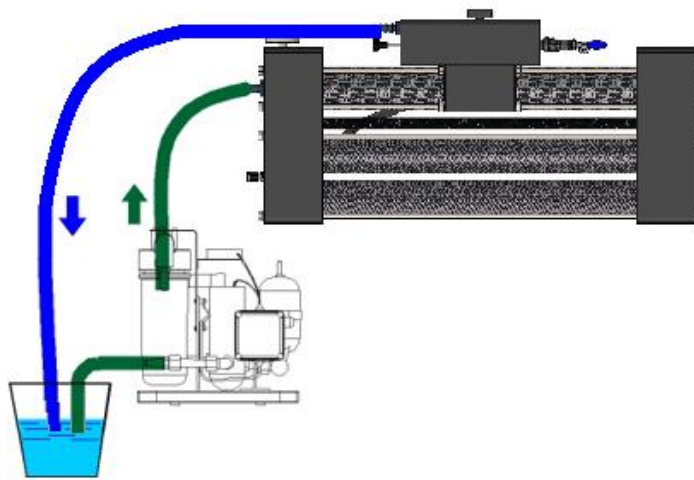

HYDRAULIC SCHEME FOR SHUTDOWN PROCEDURE  
FIG. 6-1



### NOTE

*The available products for the shutdown procedure are the following:*

- 1) **SCHENKER CLEANING 1 (SC1 – Acid product)** to remove the inorganic components and preserve the watermaker during winter break.
  - 2) **SCHENKER CLEANING 2 (SC2 – Alkaline product)** to remove the organic components (mould and bacteria) when already deposited; in this case the system and/or the water produce a “bad eggs” smell. Allow a period of 20 mins for both acid & alkaline cleaning.
- It is important that the depressurizing knob is partially opened when this is procedure is carried out.*



### NOTE

*Normally only SC1 is required, but in case of strong bad smell (organic contamination) it is recommended to use SC2 as well.*

*The sequence in this case will be SC2 first, then a flushing of the unit with fresh water, and finally the SC1. Leave the product in the system to winterize the unit.*



*It is advisable to replace the filters after performed the cleaning procedure with new ones.*

*If the unit will not be used for a long period (in example before winter) the filters can also be removed.*

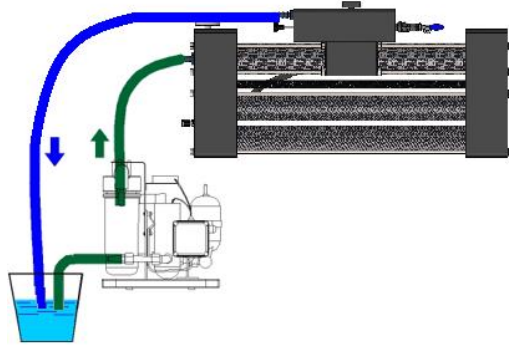
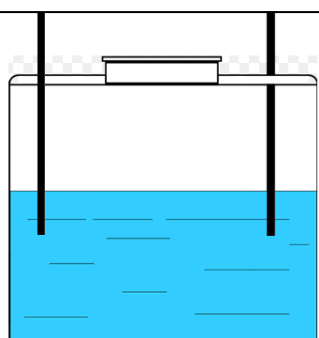
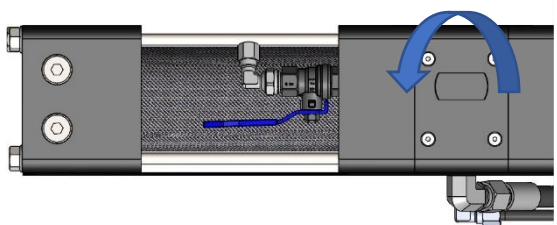
## 6.5.2 Shutdown operating procedure

|  |   |
|--|---|
| <p>1. Prepare the solution carefully mixing the bottle of SC1(or SC2) in about 15 litres of unchlorinated water.</p> |   |
| <p>2. Connect the 2 hoses to the pump and watermaker as indicated above, and dip them in the solution.</p>           |    |
| <p>3. Check they are well submerged in the solution and don't suck air.</p>  | <p style="text-align: center;"><b>Pipes under the free water surface</b></p>  |
| <p>4. <b>Open the depressurization valve.</b></p>  |   |

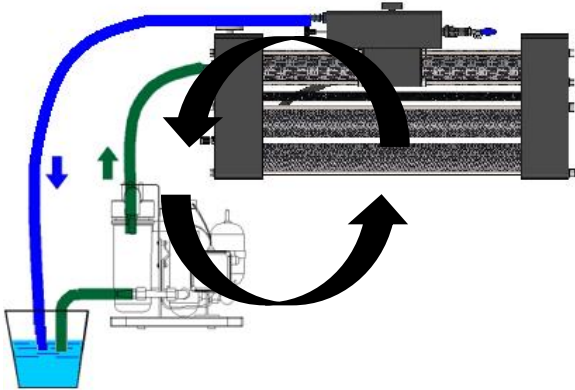

|   |  |
|---|--|
| <p>5. Start the watermaker.</p>   |  <p>A black rectangular control panel with the 'Schenker' logo at the top. It features two circular buttons. The left button is labeled 'ON / OFF' and has a blue arrow pointing to it from the left. The right button is labeled 'FLUSHING'.</p>  |
| <p>6. Leave the unit running for approx. 20 minutes, checking that the hoses are properly positioned in the recipient, so that to avoid inhaling air.</p> |  <p>A schematic diagram of the watermaker unit. A blue hose is connected to the 'ON / OFF' button and leads to a blue container. A green hose is connected to the 'FLUSHING' button and leads to a green container. Black curved arrows indicate the flow of water from the unit into the containers.</p> |
| <p>7. Stop the unit and connect the original hoses.</p>   |  <p>A black rectangular control panel with the 'Schenker' logo at the top. It features two circular buttons. The left button is labeled 'ON / OFF' and has a blue arrow pointing to it from the left. The right button is labeled 'FLUSHING'.</p>  |



**CAUTION**

*It is necessary to perform the first start-up procedure when restarting the plant after a shutdown procedure, in order to purge the air and drain out chemicals in the systems.*

## 6.6 Antifreeze procedure (Winterizing procedure in cold climate - under 5°C)

It is recommended to first perform the normal shutdown procedure by using SC1 in order to clean the system properly and prevent bacteria growth and inorganic material deposit.

After this operation, Then the system must be flushed and filled with an antifreeze.

The recommended antifreeze product is a solution of **propylene glycol and unchlorinated water**.

The ideal concentration of propylene glycol is

- 45% (for temperatures up to - 20°)
- 55% (for temperatures up to - 30°).



### ATTENTION

**Do not use ethylene glycol as this substance is toxic and non-degradable.**

The total volume of the solution must be about 15 litres.

The procedure is similar to that used for chemical washing with SC1 and SC2 products:

1. Prepare the solution carefully mixing the propylene glycol with 15 litres of unchlorinated water by following the concentration suggested above.
2. Disconnect the drain hose and the pumps suction hose.
3. Connect two hose pieces to the drain and to the pump suction.
4. Insert the end side of the hoses into the bucket, verifying that the hoses have been properly dipped in the solution and that they don't inhale air.
5. Open the depressurization valve.
6. Start the watermaker.
7. Leave the unit running for approx. 5 minutes.
8. Stop the unit and connect the original hoses. The antifreeze solution must stay in the system. Take care to not empty the system when reconnecting the hoses.

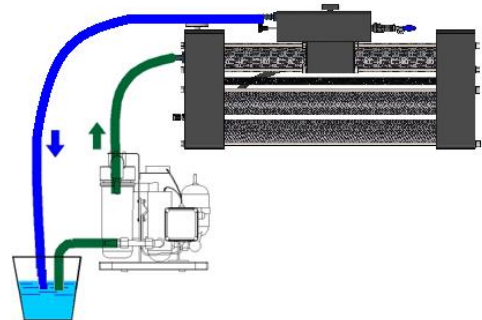

HYDRAULIC SCHEME FOR  
WINTERIZING PROCEDURE  
FIG. 6-2



### ATTENTION



**Before proceeding with any kind of service it is strongly recommended to read carefully the instructions contained in this manual.**

## 6.7 Periodic maintenance

### 6.7.1 Membrane replacement

The reverse osmosis membranes last on average 6-7 years. When the membranes are old usually the quality of water decrease and/or the working pressure increases. If chemical washings don't produce significant improvements, it is recommended to replace the membranes.

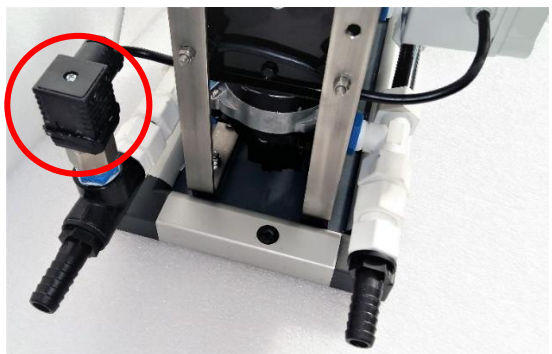
## 6.8 Adjustments

|   |   |
|---|---|
| <p><b>Pump high pressure switch</b></p> <p>The main pump is equipped with a high pressure safety switch set at around 9,5 Bar. The pressure switch can be calibrated with a screwdriver. To calibrate the pressure switch pull out the plug, remove the security nut, and engage the small internal screw with a small screw driver. Turning clockwise the calibration of the pressure switch increases, while turning anticlockwise the calibration decreases.</p> |    |
| <p><b>Accumulator</b></p> <p>This is a cylindrical plastic reservoir of air that has the function of damping the pressure oscillations during the commutations of the watermaker. The accumulator is factory loaded at a pressure of about 4 bar. The charging pressure must be periodically checked.</p>   |  |

## 7. TROUBLESHOOTING

### 7.1 Troubleshooting chart

| Issue   | Probable cause   | Remedy  |
|---|--|---|
| Pump doesn't start  | Pump pressure switch disconnected or burned<br>Electronic failure    | Restore or replace the pump pressure switch<br>Start pump and electrovalve using microswitches. |
| Pump starts but the system suddenly blocks in high pressure                                     | Hydraulic block<br>Dirty filters                                     | Perform reset procedure<br>Replace filters  |
| During operation, the pump temporarily switches off, giving rise to a start and stop phenomenon | Pump pressure switch not correctly set<br>Dirty filters or membranes | Calibrate pump pressure switch<br>Clean or replace  |
| High pressure variations during commutation (> 0,2 Bar)   | Low accumulator pressure low   | Inflate at a pressure of 4 Bar  |
| Low production / normal or low pressure   | Low battery<br>Air within the system                                 | Check battery charge<br>Purge air opening for a while the pressure valve                        |
| Low production / high pressure (> 9 Bar)  | Clogged filters<br>Clogged membranes<br>Cold seawater                | Replace filters<br>Perform washing with SC1<br>Normal condition                                 |

## 8. SUGGESTED SPARE PARTS

### 8.1 Short term cruising

For short term cruising it is advisable to have onboard a cleaning kit (one SC1 and one SC2 cleaning product) as well as one 5 microns cartridge filter. Other additional spare parts are listed below with their codes:

| Spare part name                | Code |
|--------------------------------|------|
| SC1 WASHING PRODUCT            | SC1  |
| SC2 WASHING PRODUCT            | SC2  |
| CLEANING KIT (SC1+SC2)         | CK   |
| 5 MICRON CARTRIDGE 5           | F5   |
| ACTIVE CARBON FILTER CARTRIDGE | CA   |

### 8.2 Long term cruising

For long term cruising it is advisable to have onboard a cruising kit (three x 5 microns cartridge filter, one active carbon filter, one big cleaning kit) and a signal pressure switch. Other additional spare parts are listed below with their codes:

| Spare part name               | Code     |
|-------------------------------|----------|
| SC1 WASHING PRODUCT           | SC1      |
| SC2 WASHING PRODUCT           | SC2      |
| CRUISING KIT                  | CRK136   |
| SPARE PUMP SM-MOD 30/60 12V   | SP36/12  |
| SPARE PUMP SM-MOD 30/60 24V   | SP36/24  |
| MEMBRANE 2521                 | M2521    |
| PORTABLE SALINITY TESTER      | PST      |
| PUMP PRESSURE SWITCH 30/60/50 | PSP36    |
| SPARE SEALS KIT ZEN50 2.0     | SSZ5-2.0 |

